

Peak Emission Wavelength: 1300nm



**Description**

- Size 1206: 3.2 (L) x 1.6 (W) x 1.2 (H) mm
- Circuit substrate: glass laminated epoxy
- Devices are RoHS conform
- Lead free solderable, soldering pads: gold plated
- Marking at anode
- High radiation intensity types

Absolute Maximum Ratings (Ta=25°C)



ITEMS	SYMBOL	RATINGS	UNIT
Forward DC Current	If	50	mA
Peak Forward Current *	Ifp	100	mA
Reverse Voltage	Vr	5	V
Reverse Current	Ir	100	uA
Operating Temperature	Top	-40 to +85	°C
Storage Temperature	Tst	-55 to +85	°C
Thermal Resistance	RthJA	450	K/W

\* tp ≤ 100 us, T=1ms

Electrical & Optical Characteristics (Ta = 25°C)

ITEMS	SYMBOL	CONDITION	MIN	TYP	MAX	UNIT
Forward Voltage	Vf	If=50mA	--	1.1	--	V
Peak Wavelength	λp	If=50mA	--	1300	--	nm
Radiant Power	Φe	If=50mA	--	11	--	mW
Spectral Bandwidth	Δλ0.5	If=50mA	--	78	--	nm
Viewing Angle	φ	If=50mA	--	40	--	deg

### Package Dimensions

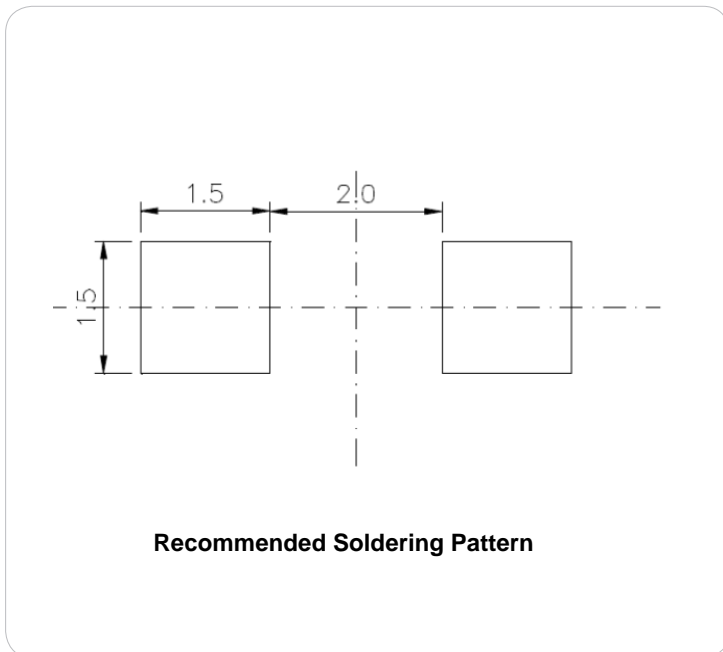
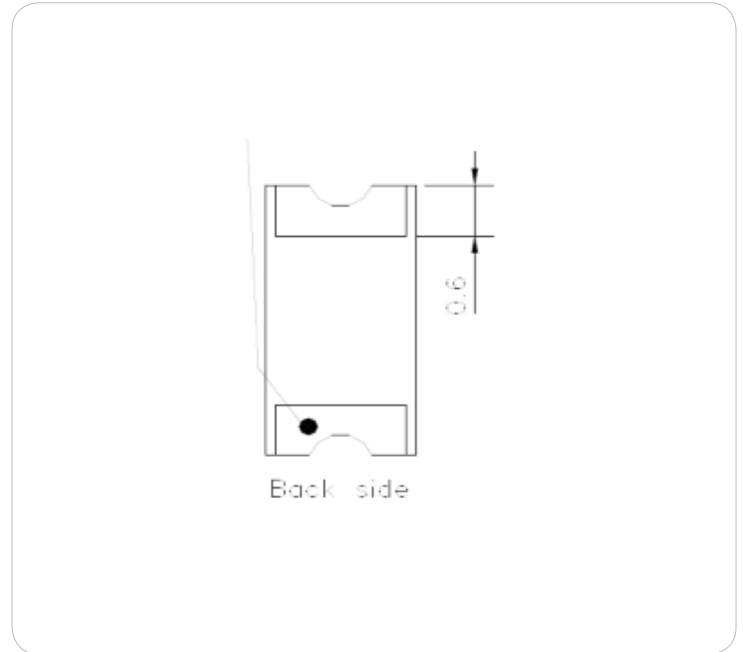
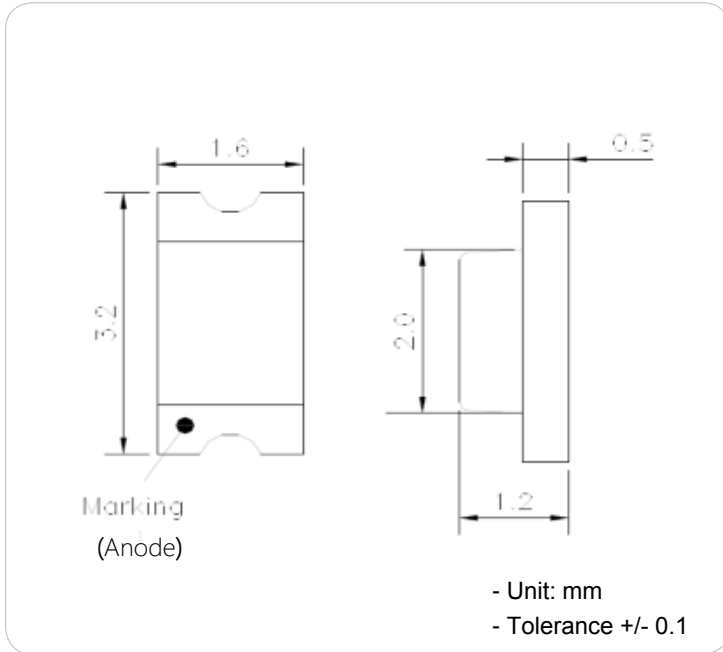

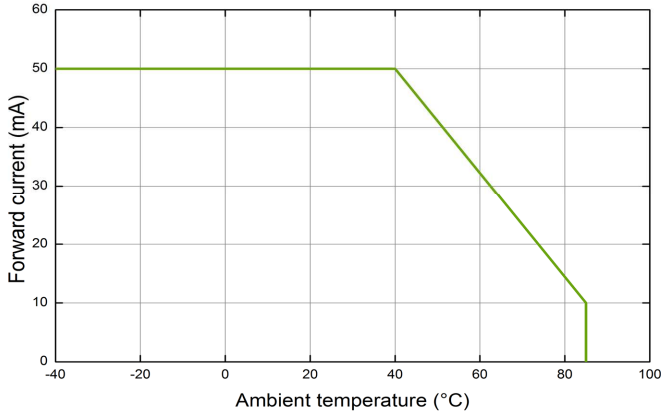

Max. forward current vs. ambient temperature

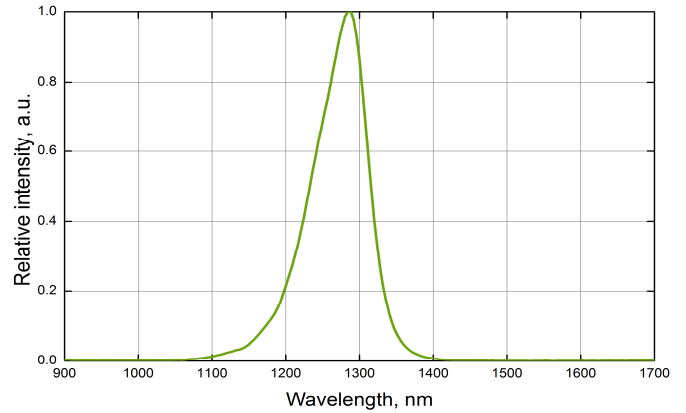

Typical spectrum at 50 mA

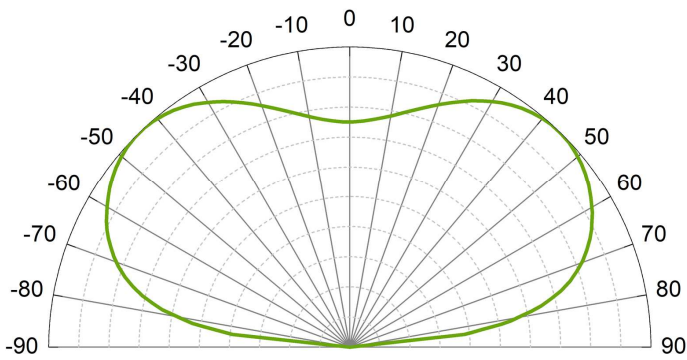

Radiation pattern

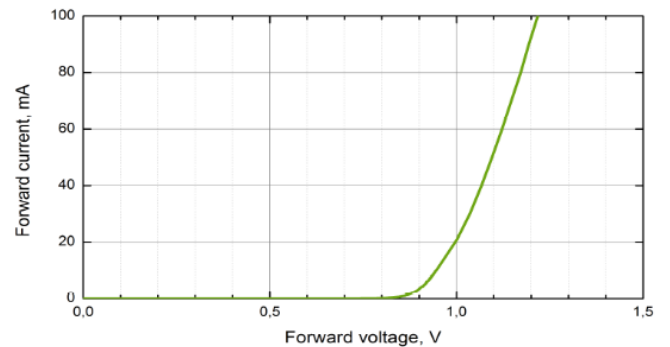

Forward current vs. forward voltage

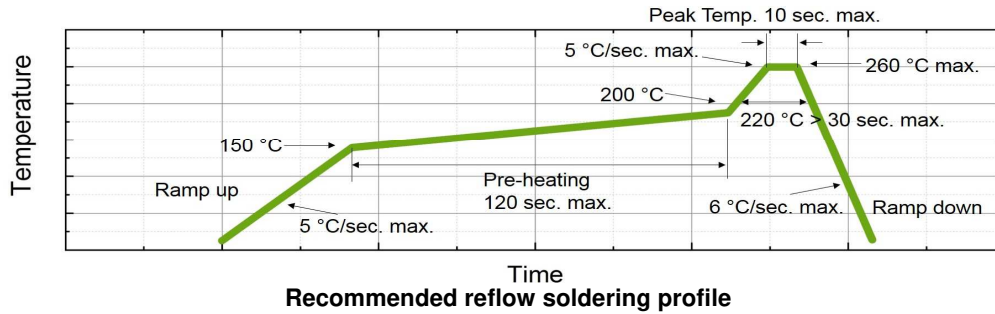

Measured according to CIE 127. All SMD LEDs are 100% measured and selected on full automated equipment with an accuracy of  $\pm 11\%$ .

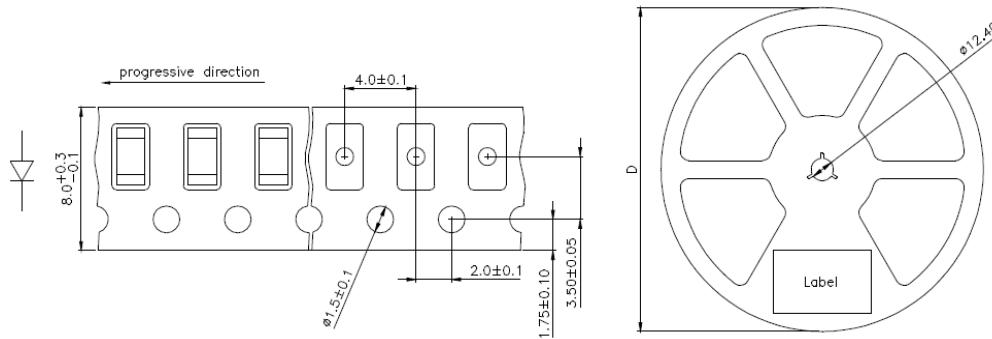

D	Parts / reel
180 mm	3000
330 mm	12000

**Tape and reel packing**

**Packing:** The reel is seaLED in special plastic bag with integrate ESD protection (MIL - STD 81705) including a silica dry-pack