

Peak Emission Wavelength: 650nm

The 650nm Point Source Series is designed for applications requiring high accuracy and precision. Custom package solutions and sorting are available.

FEATURES

- > PLCC-4 Package
- > Emitting Window Diameter Φ 160 μ m
- > High Reliability / High Output Power

APPLICATIONS

- > Optical Sensing
- > Linear & Rotary Encoder
- > Machine Vision / CCD
- > Optical Instruments

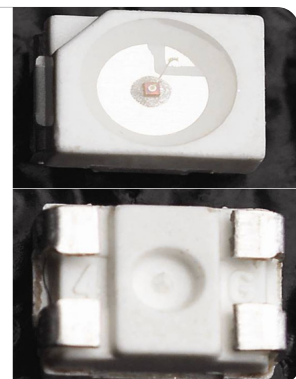

Absolute Maximum Ratings (Ta=25°C)



ITEMS	SYMBOL	RATINGS	UNIT
Forward Current	IF	30	mA
Forward Current (Pulse)*1	IFP	150	mA
Reverse Voltage	VR	5	V
Power Dissipation	PD	80	mW
Operating Temperature Range	Topr	-20 ~ +80	°C
Storage Temperature Range	Tstg	-30 ~ +100	°C

*1: Tw=10 μ sec, T=10msec.

Electrical & Optical Characteristics (Ta = 25°C)

ITEMS	SYMBOL	CONDITIONS	MIN	TYP	MAX	UNIT
Power Output	PO	IF=20mA	1.8	2.4	--	mW
Forward Voltage	VF	IF=20mA	--	2.2	2.5	V
Reverse Current	IR	VR=5V	--	--	10	μ A
Peak Emission Wavelength	λ_p	IF=20mA	630	650	670	nm
Spectral Line Half Width	$\Delta\lambda$	IF=20mA	--	20	--	nm
Half Intensity Beam Angle	Θ	IF=20mA	--	± 50	--	deg

*1: Tw=10 μ sec, T=10msec.

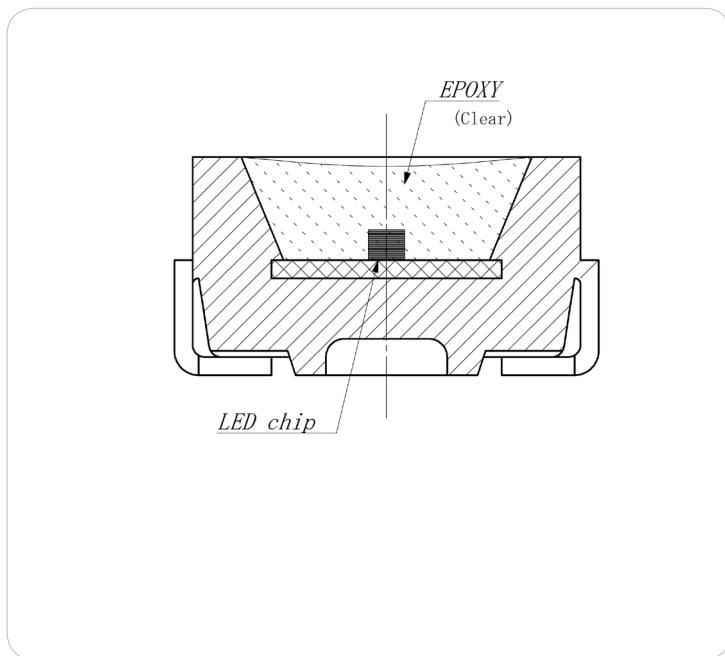
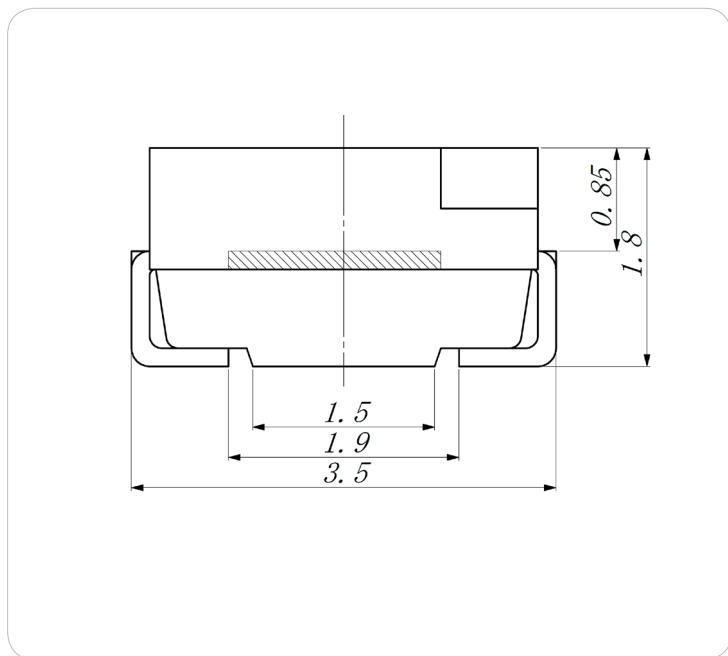
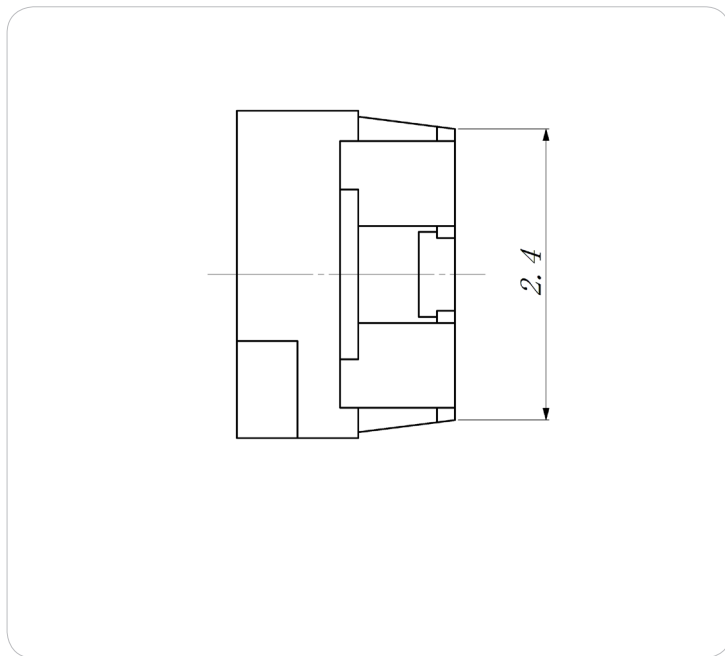
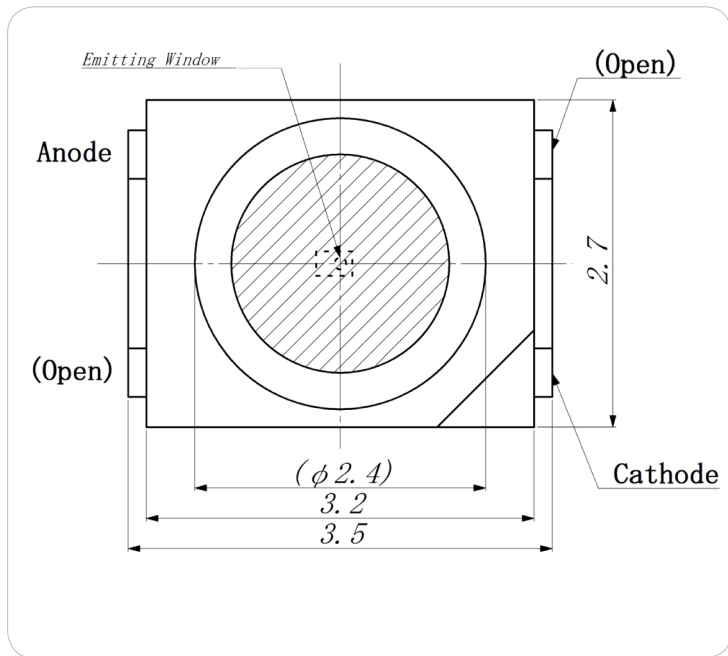

Unit: mm, Tolerance: ± 0.2

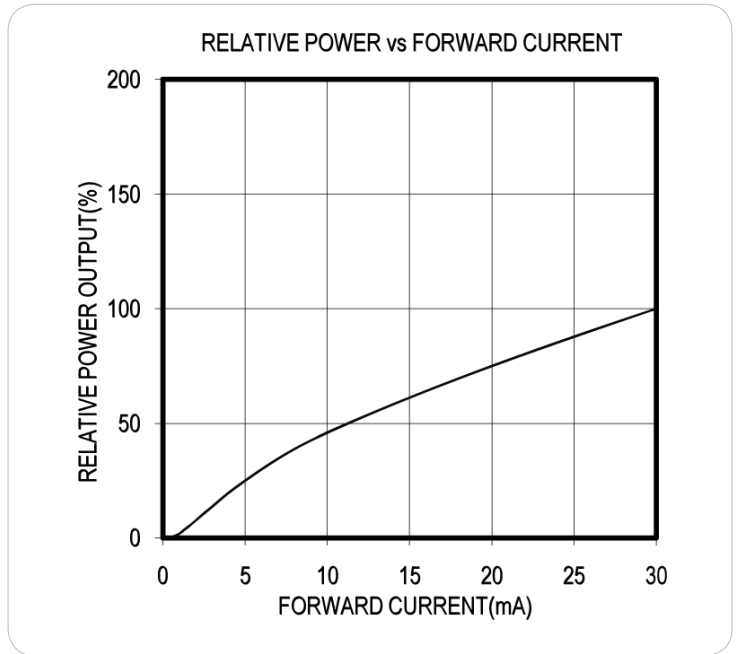
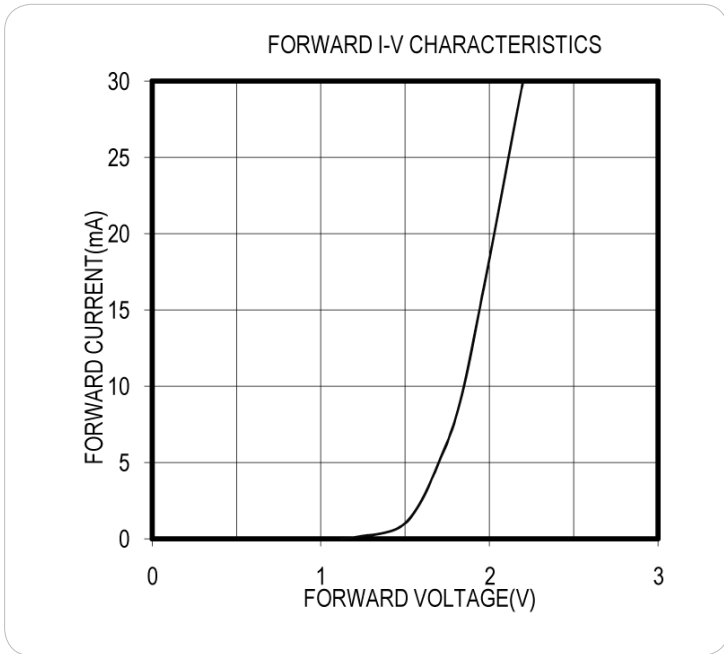
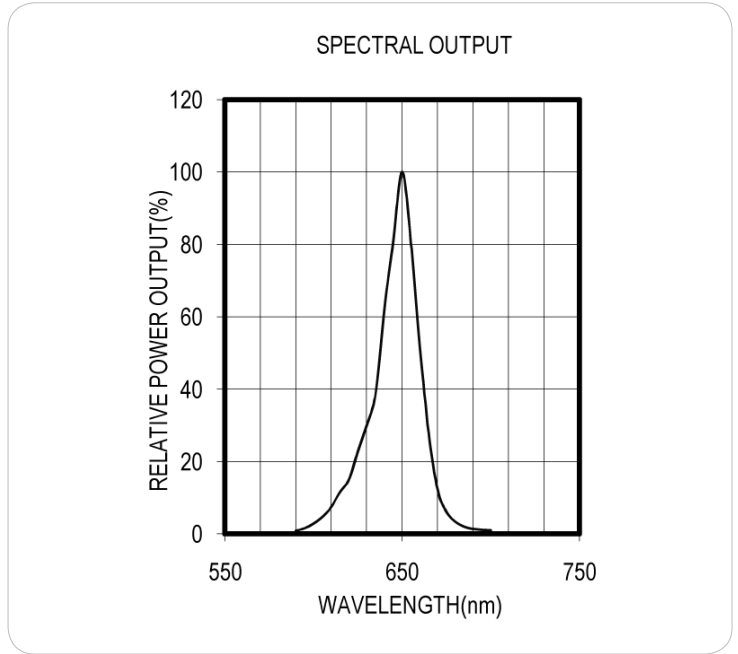
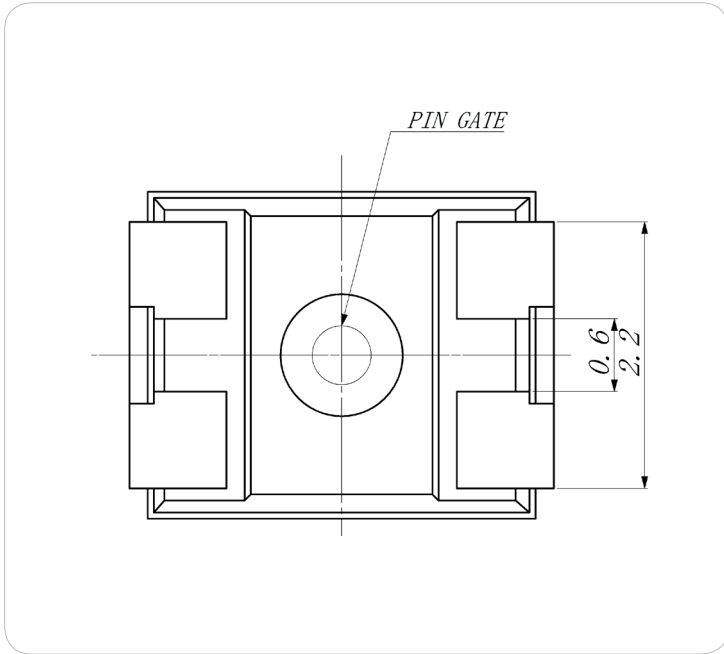

Unit: mm, Tolerance: ± 0.2

2020-06-09

RADIATION PATTERN

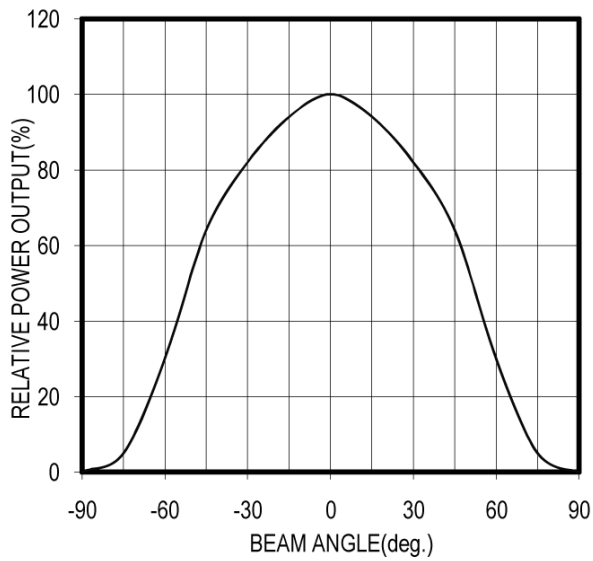

THERMAL DERATING CURVE

