

Peak Emission Wavelength: 525nm

The 525nm visible emitter series is designed for applications requiring high output and precise optical / mechanical axis alignment. Custom package solutions and sorting are available.

FEATURES

- > Ceramic Package
- > High Output Power
- > Compact
- > Narrow Viewing Angle

APPLICATIONS

- > Display
- > Indicators
- > Light Source for Sensor
- > Optical Switches

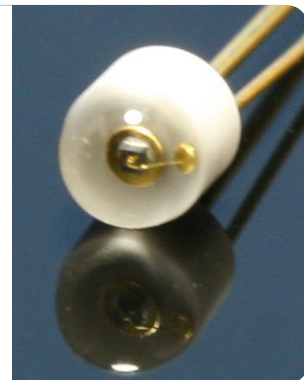

Absolute Maximum Ratings (Ta=25°C)



ITEMS	SYMBOL	RATINGS	UNIT
Forward Current (DC)	IF	20	mA
Forward Current (Pulse)*1	IFP	100	mA
Reverse Voltage	VR	5	V
Power Dissipation	PD	80	mW
Operating Temperature Range	Topr	-20 ~ +80	°C
Storage Temperature Range	Tstg	-30 ~ +100	°C
Junction Temperature	Tj	100	°C
Lead Soldering Temperature*2	Tls	260	°C

*1: Tw=10μsec, T=10msec. *2: Time 5 Sec max, Position: Up to 3mm from the body.

Electrical & Optical Characteristics (Ta = 25°C)

ITEMS	SYMBOL	CONDITIONS	MIN	TYP	MAX	UNIT
Power Output	PO	IF=20mA	--	5.0	--	mW
Forward Voltage	VF	IF=20mA	--	3.0	3.5	V
Reverse Current	IR	VR=5V	--	--	100	μA
Peak Emission Wavelength	λp	IF=20mA	--	525	--	nm
Spectral Line Half Width	Δλ	IF=20mA	--	35	--	nm
Half Intensity Beam Angle	Θ	IF=20mA	--	±3	--	deg

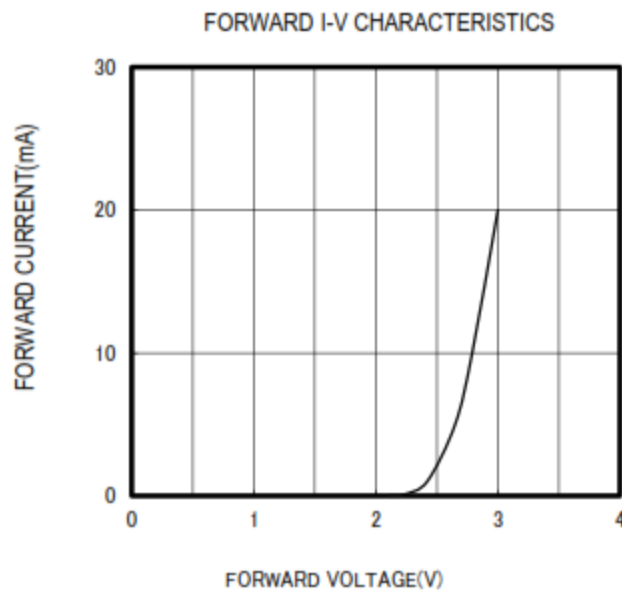
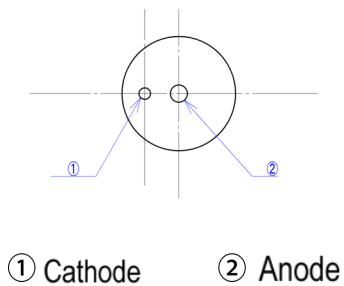
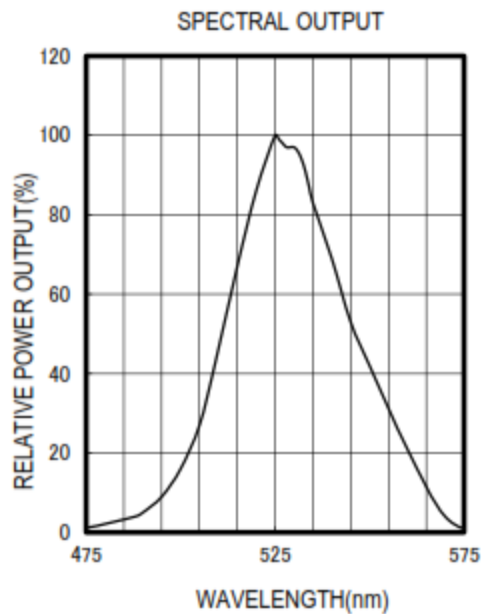
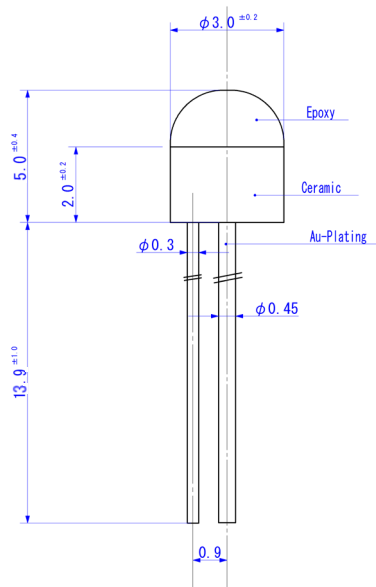

Unit: mm, Tolerance: ± 0.2

THERMAL DERATING CURVE

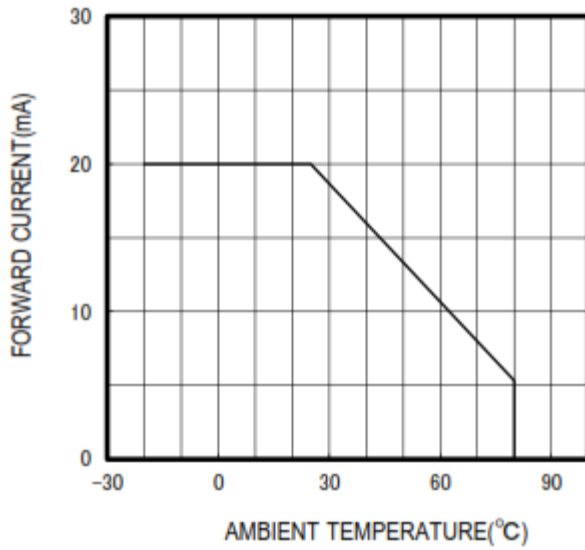

RELATIVE POWER vs FORWARD CURRENT

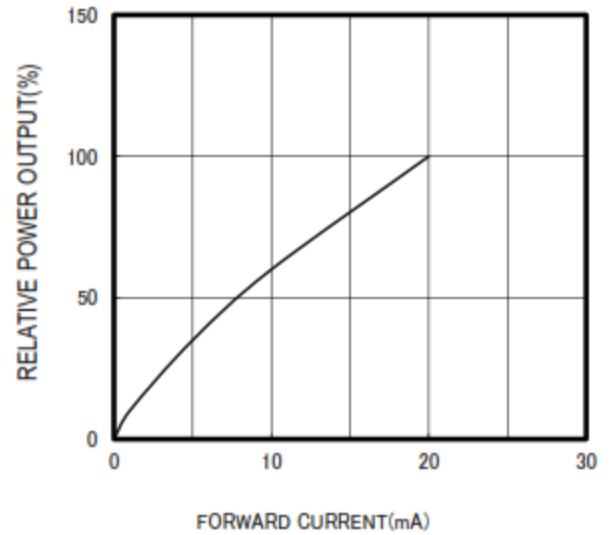

RADIATION DISTRIBUTION

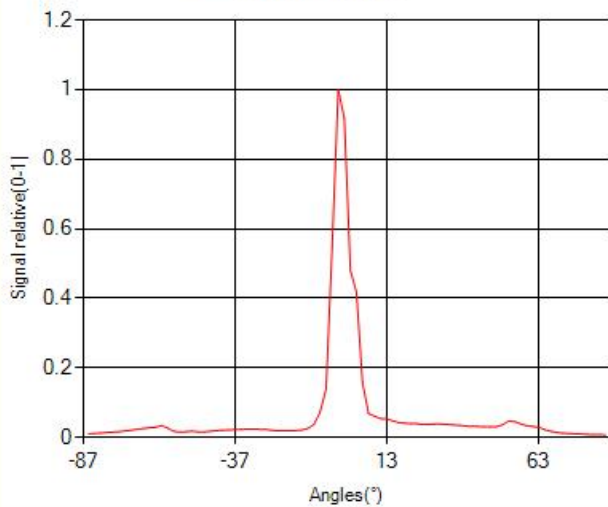

VIEW ANGLE

