

Peak Sensitivity Wavelength: 940nm

The MT03-004 is a square quadrant with a total active area of 5.8mm² (4 x 1.44mm²) with a 50um gap in a hermetic TO-5 metal can package. It is well suited for applications requiring high sensitivity (Green/Blue) as well as visible-near IR applications.

FEATURES

- > Ultra Low Noise
- > High Shunt Resistance
- > Wide Dynamic Range
- > Blue Enhanced

APPLICATIONS

- > Colorimeters
- > Beam centering
- > Optical Encoders
- > Fluorescence

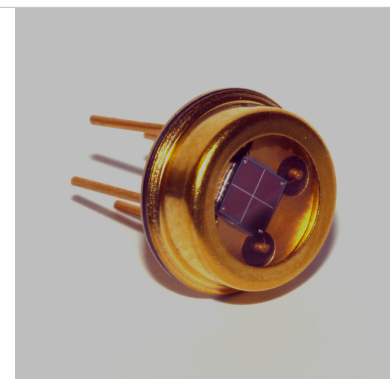

Absolute Maximum Ratings



ITEMS	SYMBOL	RATINGS	UNIT
Reverse Voltage	VR	50	V
Operating Temperature Range	Topr	-40 ~ +100	°C
Storage Temperature Range	Tstg	-55 ~ +125	°C
Lead Soldering Temperature *1	Tls	260	°C

*1: Time 5 Sec max, Position: Up to 3mm from the body.

Electrical & Optical Characteristics (Ta = 25°C)

ITEMS	SYMBOL	CONDITIONS	MIN	TYP	MAX	UNIT
Light Current	IL	*1, *2	--	--	10.0	mA
Dark Current	ID	VR=10V	--	0.5 per ele	1.0 per ele	nA
Spectral Sensitivity	λ	--	--	400~1100	--	nm
Peak Sensitivity Wavelength	λp	--	--	940	--	nm
Responsivity	Rt	VR=0V, λ=410nm	--	0.22	--	A/W
Responsivity	Rt	VR=0V, λ=940nm	--	0.60	--	A/W
Response Time @850nm	Tr	RL=50Ω, Vr=10V	--	20.0	22.0	nS
Junction Capacitance	Cj	at 1MHz, V=0V per ele	--	20	25	pF
Junction Capacitance	Cj	at 1MHz, V=10V per ele	--	3.5	6.0	pF
Shunt Resistance	Rs	Vr=10mV	200	250	--	MΩ

*1: Color Temperature=2870°K Standard Tungsten Lamp, *2: VR=10V, Ee=5mW/cm².

TO-5 Package Dimensions (5 Pin)

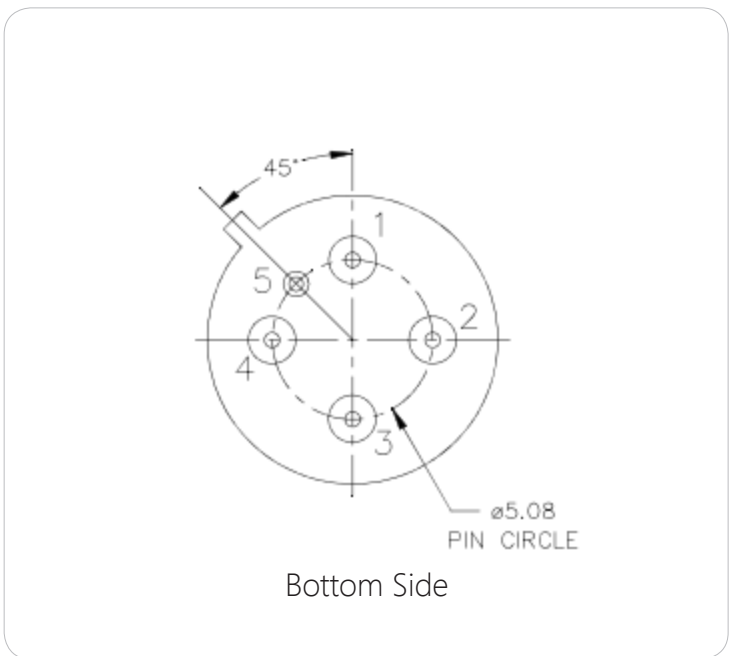
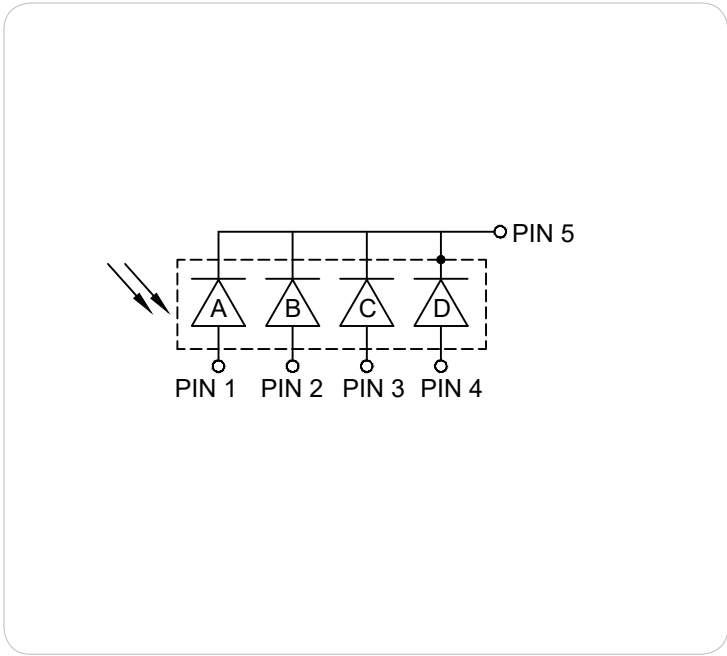
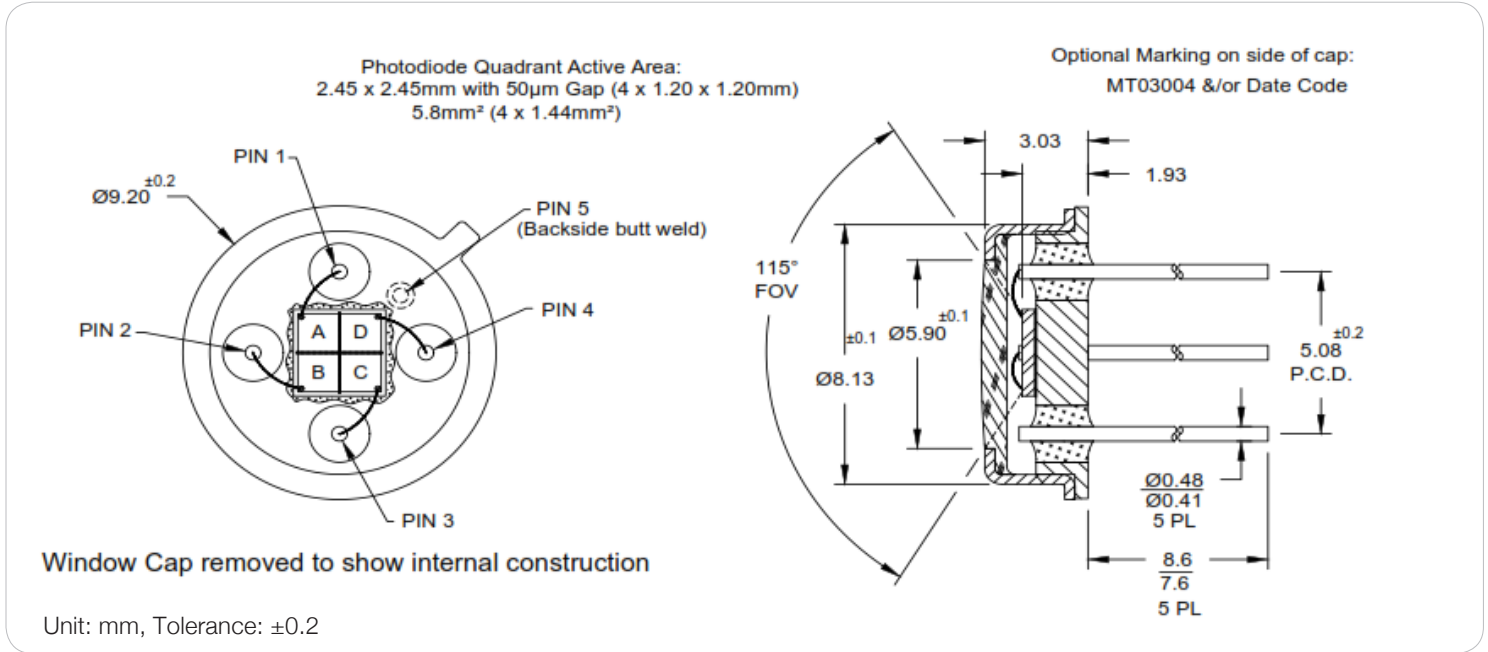

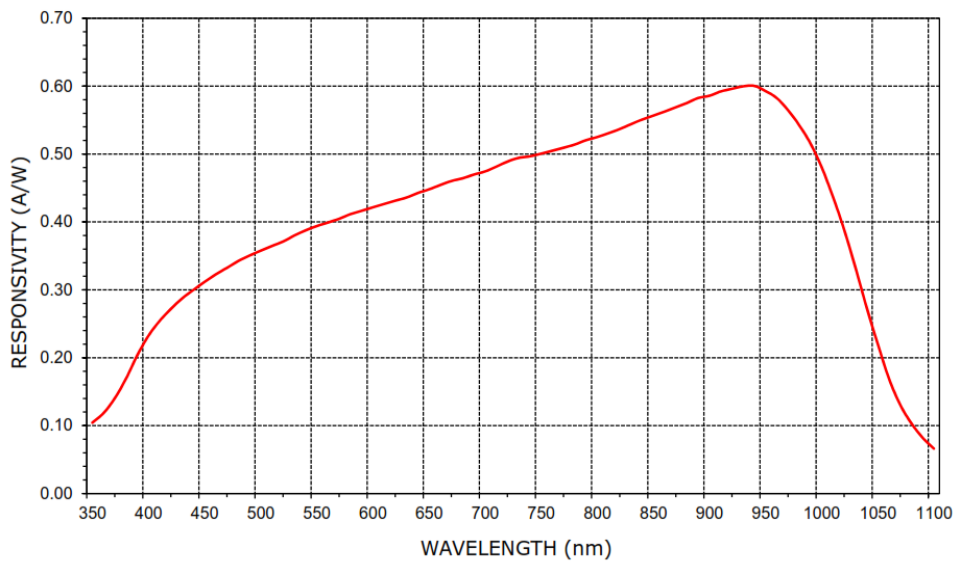
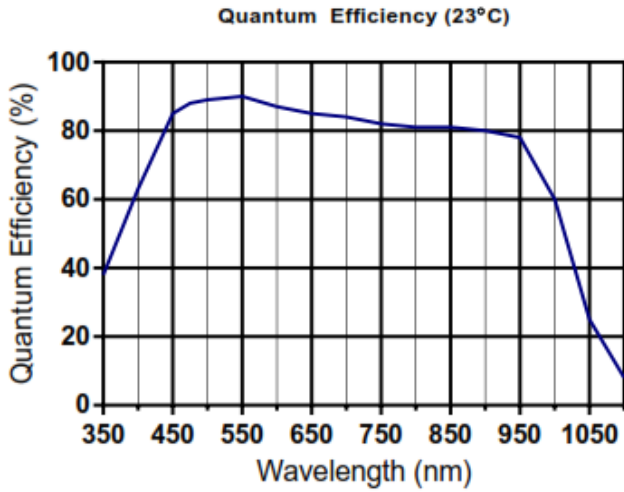

The information contained herein is subject to change without notice.

2018-01-02