

Sensitivity Wavelength Range: 350-1100nm

The MT03-002 is a circular ($\varnothing 3.57$) 10mm² active area Silicon Photodiode in a hermetic TO-5 metal can package with a glass window. It is well suited for applications requiring visible and near infrared (NIR) light detection.

Features

- > Ultra Low Noise
- > High Shunt Resistance
- > Wide Dynamic Range
- > Broadband Spectral Coverage

Applications

- > Colorimeters
- > Photometers
- > Spectroscopy Equipment
- > Fluorescence

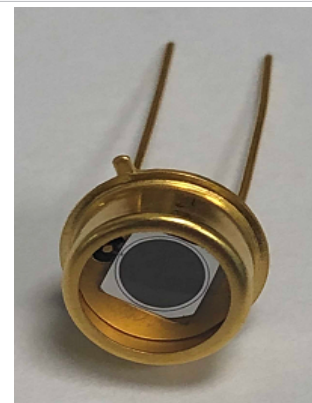

Absolute Maximum Ratings



Items	Symbol	Rating	Unit
Reverse Voltage	V _R	50	V
Operating Temperature Range	T _{opr}	-40 ~ +100	°C
Storage Temperature Range	T _{stg}	-55 ~ +125	°C
Lead Soldering Temperature*1	T _{ls}	260	°C

*1: Time 5 Sec max, Position: Up to 3mm from the body.

Electrical & Optical Characteristics (T_a = 23°C)

Items	Symbol	Conditions	MIN	TYP	MAX	Unit
Dark Current	I _d	V _R =5V	--	0.5	2.0	nA
Breakdown Voltage	V _(BR)	I _R =10μA	50	--	--	V
Spectral Sensitivity	λ	--	--	350-1100	--	nm
Peak Sensitivity	λ _p	--	--	950	--	nm
Wavelength Responsivity	R	V _R =0V, λ=633nm	--	0.45	--	A/W
Responsivity	R	V _R =0V, λ=950nm	--	0.63	--	A/W
Response Time @808nm	T _r	R _L =50Ω, V _R =5V	--	80	--	ns
Junction Capacitance	C _j	@ 1MHz, V _R =0V	--	220	--	pF
Junction Capacitance	C _j	@ 1MHz, V _R =5V	--	52	60	pF
Shunt Resistance	R _{sh}	V _R =10mV	250	500	--	MΩ

TO-5 Package Dimensions (2 Pin)

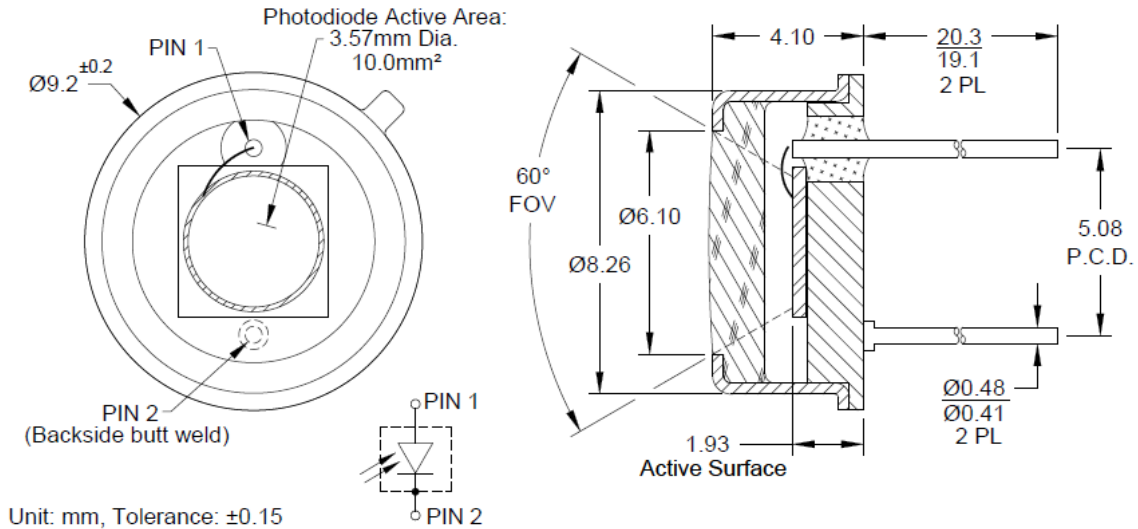

Capacitance vs Reverse Bias

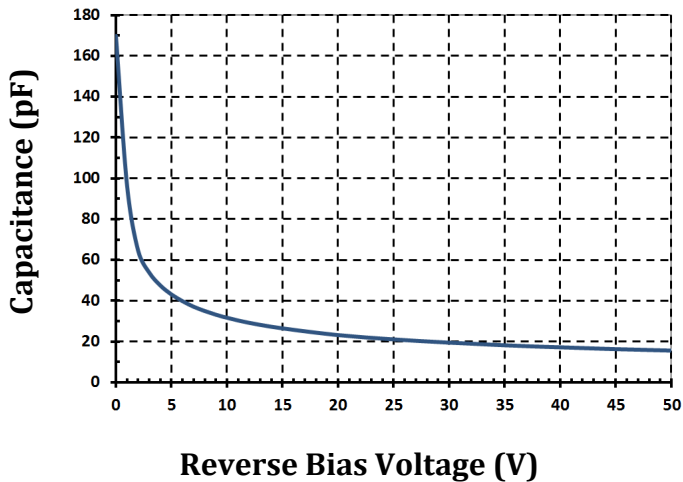

Dark Current vs Reverse Bias (23°C)

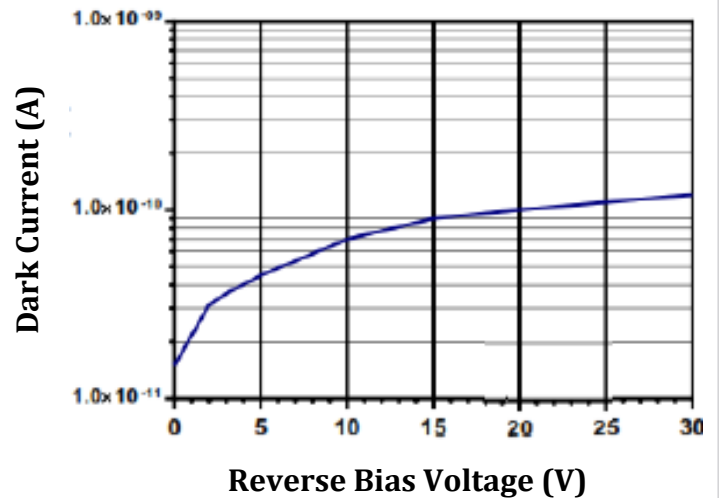

Dark Current vs Temperature ($V_r=10V$)

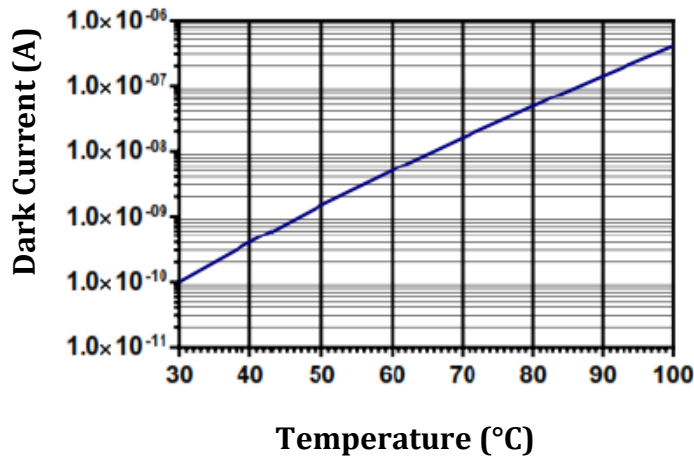

Series 11 Quantum Efficiency (23°C)

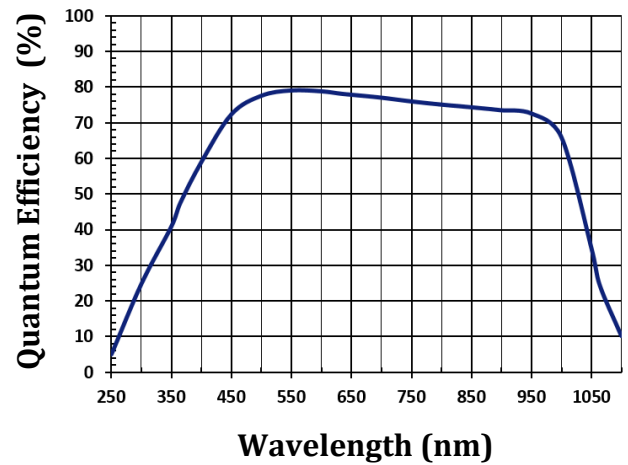

Marktech Optoelectronics Series 11 Responsivity

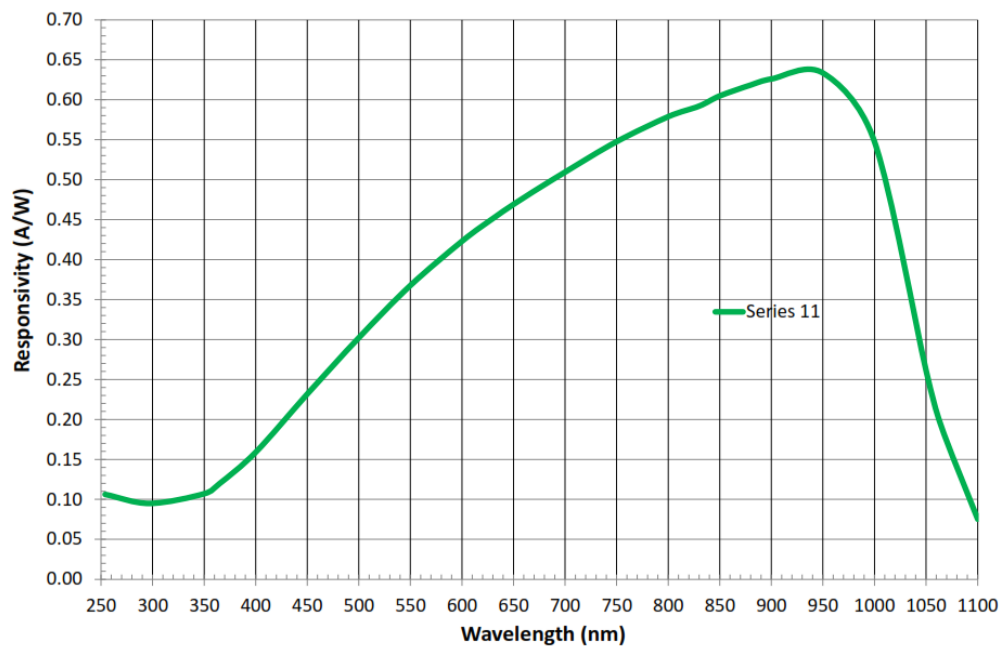

The information contained herein is subject to change without notice.

2026-05-01

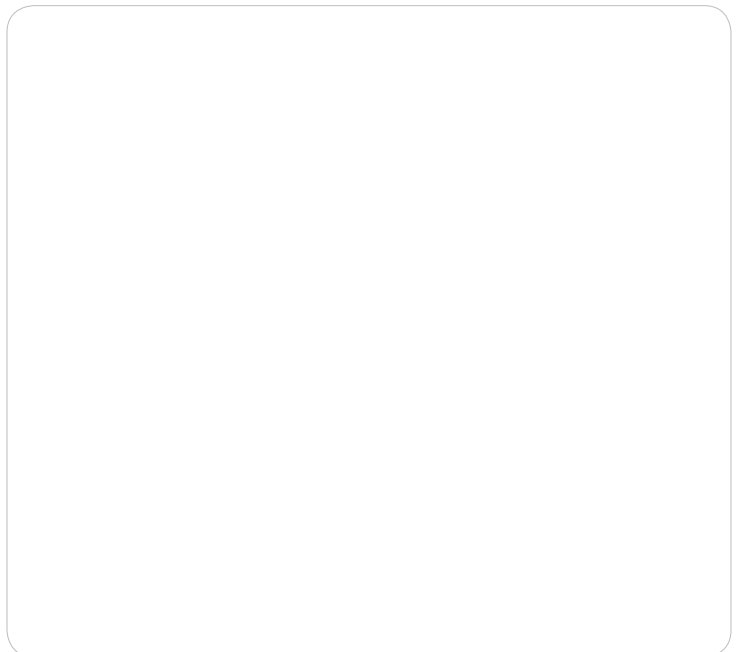

Photodiode Responsivity by Series

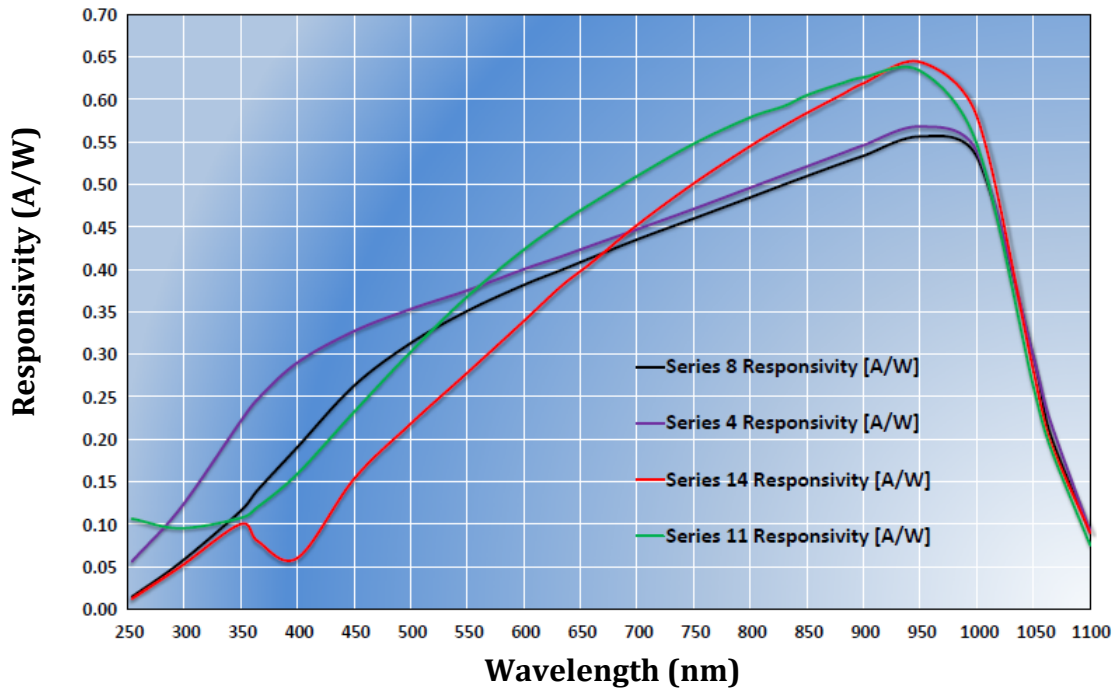

The information contained herein is subject to change without notice.

2026-05-01