

# Cree® 5mm Oval LED

## C566C-RFS/GFS/BFS/AFS

## C566C-RFN/GFN/BFN/AFN

This oval LED is specifically designed for variable-message signs and passenger-information signs. The oval-shaped radiation pattern and high luminous intensity ensure that these devices are excellent for wide-field-of-view outdoor applications where a wide viewing angle and readability in sunlight are essential.

These lamps are tinted and diffused. The encapsulation resin contains anti-UV material in order to reduce the effects of long-term exposure to direct sunlight.



### FEATURES

- Size (mm): 5
- Color and Typical Dominant Wavelength (nm):
  - » Red(621)
  - » Green (527)
  - » Blue (470)
  - » Amber (591)
- Luminous Intensity (mcd)
  - » Red (1100-4180)
  - » Green (2130-12000)
  - » Blue (770-4180)
  - » Amber (1520-4180)
- Viewing Angle: 70 x 35 degree
- Lead-Free
- RoHS-Compliant

### APPLICATIONS

- Electronic Signs & Signals (ESS)
- Full-Color Video Screen
- Motorway Signs
- Variable-Message Sign (VMS)
- Advertising Signs
- Petrol Signs



## Absolute Maximum Ratings ( $T_A = 25^\circ\text{C}$ )

Items	Symbol	Absolute Maximum Rating		Unit
		Red and Amber	Blue and Green	
Forward Current	$I_F$	50 <sup>Note1</sup>	35	mA
Peak Forward Current <sup>Note2</sup>	$I_{FP}$	200	100	mA
Reverse Voltage	$V_R$	5	5	V
Power Dissipation	$P_D$	130	140	mW
Operation Temperature	$T_{opr}$	-40 ~ +95		$^\circ\text{C}$
Storage Temperature	$T_{stg}$	-40 ~ +100		$^\circ\text{C}$
Lead Soldering Temperature	$T_{sol}$	Max. 260 $^\circ\text{C}$ for 3 sec. max. (3 mm from the base of the epoxy bulb)		
Electrostatic Discharge Classification (MIL-STD-883E)	ESD	Class 2		

### Note:

1. For long-term performance, the drive currents between 10 mA and 30 mA are recommended. Please contact a Cree sales representative for more information on recommended drive conditions.
2. Pulse width  $\leq 0.1$  msec, duty  $\leq 1/10$ .

## Typical Electrical & Optical Characteristics ( $T_A = 25^\circ\text{C}$ )

Characteristics	Color	Symbol	Condition	Unit	Minimum	Typical	Maximum
Forward Voltage	Red/Amber	$V_F$	$I_F = 20$ mA	V		2.1	2.6
	Blue/Green	$V_F$	$I_F = 20$ mA	V		3.4	4.0
Reverse Current	Red/Amber	$I_R$	$V_R = 5$ V	$\mu\text{A}$			100
	Blue/Green	$I_R$	$V_R = 5$ V	$\mu\text{A}$			100
Dominant Wavelength	Red	$\lambda_D$	$I_F = 20$ mA	nm	619	621	624
	Green	$\lambda_D$	$I_F = 20$ mA	nm	520	527	535
	Blue	$\lambda_D$	$I_F = 20$ mA	nm	460	470	475
	Amber	$\lambda_D$	$I_F = 20$ mA	nm	584	591	596
Luminous Intensity	Red	$I_V$	$I_F = 20$ mA	mcd	1100	2200	
	Green	$I_V$	$I_F = 20$ mA	mcd	2130	5200	
	Blue	$I_V$	$I_F = 20$ mA	mcd	770	1500	
	Amber	$I_V$	$I_F = 20$ mA	mcd	1520	2500	



## Intensity Bin Limit ( $I_f = 20 \text{ mA}$ )

### Red

Bin Code	Min.(mcd)	Max.(mcd)
T0	1100	1520
U0	1520	2130
V0	2130	3000
W0	3000	4180

### Amber

Bin Code	Min.(mcd)	Max.(mcd)
U0	1520	2130
V0	2130	3000
W0	3000	4180

### Green

Bin Code	Min.(mcd)	Max.(mcd)
V0	2130	3000
W0	3000	4180
X0	4180	5860
Y0	5860	8200
Z0	8200	12000

### Blue

Bin Code	Min.(mcd)	Max.(mcd)
S0	770	1100
T0	1100	1520
U0	1520	2130
V0	2130	3000
W0	3000	4180

Tolerance of measurement of luminous intensity is  $\pm 15\%$

## Color Bin Limit ( $I_f = 20 \text{ mA}$ )

### Red

Bin Code	Min.(nm)	Max.(nm)
RB	619	624

### Amber

Bin Code	Min.(nm)	Max.(nm)
A2	584	587
A3	587	590
A4	590	593
A5	593	596

### Green

Bin Code	Min.(nm)	Max.(nm)
G7	520	525
G8	525	530
G9	530	535

### Blue

Bin Code	Min.(nm)	Max.(nm)
B3	460	465
B4	465	470
B5	470	475

Tolerance of measurement of dominant wavelength is  $\pm 1 \text{ nm}$



## Order Code Table\*

Color	Kit Number	Luminous Intensity (mcd)		Dominant Wavelength				Package	Standoff
		Min.	Max.	Color Bin	Min. (nm)	Color Bin	Max. (nm)		
Red	C566C-RFS-CT0W0BB1	1100	4180	RB	619	RB	624	Bulk	Yes
Red	C566C-RFS-CU0V0BB1	1520	3000	RB	619	RB	624	Bulk	Yes
Red	C566C-RFS-CV0W0BB1	2130	4180	RB	619	RB	624	Bulk	Yes
Red	C566C-RFN-CT0W0BB1	1100	4180	RB	619	RB	624	Bulk	No
Red	C566C-RFN-CU0V0BB1	1520	3000	RB	619	RB	624	Bulk	No
Red	C566C-RFN-CV0W0BB1	2130	4180	RB	619	RB	624	Bulk	No
Red	C566C-RFS-CT0W0BB2	1100	4180	RB	619	RB	624	Ammo	Yes
Red	C566C-RFS-CU0V0BB2	1520	3000	RB	619	RB	624	Ammo	Yes
Red	C566C-RFS-CV0W0BB2	2130	4180	RB	619	RB	624	Ammo	Yes
Red	C566C-RFN-CT0W0BB2	1100	4180	RB	619	RB	624	Ammo	No
Red	C566C-RFN-CU0V0BB2	1520	3000	RB	619	RB	624	Ammo	No
Red	C566C-RFN-CV0W0BB2	2130	4180	RB	619	RB	624	Ammo	No

Color	Kit Number	Luminous Intensity (mcd)		Dominant Wavelength				Package	Standoff
		Min.	Max.	Color Bin	Min. (nm)	Color Bin	Max. (nm)		
Green	C566C-GFS-CV0Z0791	2130	12000	G7	520	G9	535	Bulk	Yes
Green	C566C-GFS-CV0Z0891	2130	12000	G8	525	G9	535	Bulk	Yes
Green	C566C-GFS-CW0X0781	3000	5860	G7	520	G8	530	Bulk	Yes
Green	C566C-GFS-CW0X0891	3000	5860	G8	525	G9	535	Bulk	Yes
Green	C566C-GFS-CX0Y0781	4180	8200	G7	520	G8	530	Bulk	Yes
Green	C566C-GFS-CX0Y0891	4180	8200	G8	525	G9	535	Bulk	Yes
Green	C566C-GFN-CV0Z0791	2130	12000	G7	520	G9	535	Bulk	No
Green	C566C-GFN-CV0Z0891	2130	12000	G8	525	G9	535	Bulk	No
Green	C566C-GFN-CW0X0781	3000	5860	G7	520	G8	530	Bulk	No
Green	C566C-GFN-CW0X0891	3000	5860	G8	525	G9	535	Bulk	No
Green	C566C-GFN-CX0Y0781	4180	8200	G7	520	G8	530	Bulk	No
Green	C566C-GFN-CX0Y0891	4180	8200	G8	525	G9	535	Bulk	No
Green	C566C-GFS-CV0Z0792	2130	12000	G7	520	G9	535	Ammo	Yes
Green	C566C-GFS-CV0Z0892	2130	12000	G8	525	G9	535	Ammo	Yes
Green	C566C-GFS-CW0X0782	3000	5860	G7	520	G8	530	Ammo	Yes
Green	C566C-GFS-CW0X0892	3000	5860	G8	525	G9	535	Ammo	Yes
Green	C566C-GFS-CX0Y0782	4180	8200	G7	520	G8	530	Ammo	Yes
Green	C566C-GFS-CX0Y0892	4180	8200	G8	525	G9	535	Ammo	Yes
Green	C566C-GFN-CV0Z0792	2130	12000	G7	520	G9	535	Ammo	No
Green	C566C-GFN-CV0Z0892	2130	12000	G8	525	G9	535	Ammo	No
Green	C566C-GFN-CW0X0782	3000	5860	G7	520	G8	530	Ammo	No
Green	C566C-GFN-CW0X0892	3000	5860	G8	525	G9	535	Ammo	No
Green	C566C-GFN-CX0Y0782	4180	8200	G7	520	G8	530	Ammo	No
Green	C566C-GFN-CX0Y0892	4180	8200	G8	525	G9	535	Ammo	No



## Order Code Table\*

Color	Kit Number	Luminous Intensity (mcd)		Dominant Wavelength				Package	Standoff
		Min.	Max.	Color Bin	Min. (nm)	Color Bin	Max. (nm)		
Blue	C566C-BFS-CS0W0351	770	4180	B3	460	B5	475	Bulk	Yes
Blue	C566C-BFS-CS0W0451	770	4180	B4	465	B5	475	Bulk	Yes
Blue	C566C-BFS-CT0U0341	1100	2130	B3	460	B4	470	Bulk	Yes
Blue	C566C-BFS-CT0U0451	1100	2130	B4	465	B5	475	Bulk	Yes
Blue	C566C-BFS-CU0V0341	1520	3000	B3	460	B4	470	Bulk	Yes
Blue	C566C-BFS-CU0V0451	1520	3000	B4	465	B5	475	Bulk	Yes
Blue	C566C-BFN-CS0W0351	770	4180	B3	460	B5	475	Bulk	No
Blue	C566C-BFN-CS0W0451	770	4180	B4	465	B5	475	Bulk	No
Blue	C566C-BFN-CT0U0341	1100	2130	B3	460	B4	470	Bulk	No
Blue	C566C-BFN-CT0U0451	1100	2130	B4	465	B5	475	Bulk	No
Blue	C566C-BFN-CU0V0341	1520	3000	B3	460	B4	470	Bulk	No
Blue	C566C-BFN-CU0V0451	1520	3000	B4	465	B5	475	Bulk	No
Blue	C566C-BFS-CS0W0352	770	4180	B3	460	B5	475	Ammo	Yes
Blue	C566C-BFS-CS0W0452	770	4180	B4	465	B5	475	Ammo	Yes
Blue	C566C-BFS-CT0U0342	1100	2130	B3	460	B4	470	Ammo	Yes
Blue	C566C-BFS-CT0U0452	1100	2130	B4	465	B5	475	Ammo	Yes
Blue	C566C-BFS-CU0V0342	1520	3000	B3	460	B4	470	Ammo	Yes
Blue	C566C-BFS-CU0V0452	1520	3000	B4	465	B5	475	Ammo	Yes
Blue	C566C-BFN-CS0W0352	770	4180	B3	460	B5	475	Ammo	No
Blue	C566C-BFN-CS0W0452	770	4180	B4	465	B5	475	Ammo	No
Blue	C566C-BFN-CT0U0342	1100	2130	B3	460	B4	470	Ammo	No
Blue	C566C-BFN-CT0U0452	1100	2130	B4	465	B5	475	Ammo	No
Blue	C566C-BFN-CU0V0342	1520	3000	B3	460	B4	470	Ammo	No
Blue	C566C-BFN-CU0V0452	1520	3000	B4	465	B5	475	Ammo	No



## Order Code Table\*

Color	Kit Number	Luminous Intensity (mcd)		Dominant Wavelength				Package	Standoff
		Min.	Max.	Color Bin	Min. (nm)	Color Bin	Max. (nm)		
Amber	C566C-AFS-CU0W0251	1520	4180	A2	584	A5	596	Bulk	Yes
Amber	C566C-AFS-CU0V0341	1520	3000	A3	587	A4	593	Bulk	Yes
Amber	C566C-AFS-CV0W0341	2130	4180	A3	587	A4	593	Bulk	Yes
Amber	C566C-AFN-CU0W0251	1520	4180	A2	584	A5	596	Bulk	No
Amber	C566C-AFN-CU0V0341	1520	3000	A3	587	A4	593	Bulk	No
Amber	C566C-AFN-CV0W0341	2130	4180	A3	587	A4	593	Bulk	No
Amber	C566C-AFS-CU0W0252	1520	4180	A2	584	A5	596	Ammo	Yes
Amber	C566C-AFS-CU0V0342	1520	3000	A3	587	A4	593	Ammo	Yes
Amber	C566C-AFS-CV0W0342	2130	4180	A3	587	A4	593	Ammo	Yes
Amber	C566C-AFN-CU0W0252	1520	4180	A2	584	A5	596	Ammo	No
Amber	C566C-AFN-CU0V0342	1520	3000	A3	587	A4	593	Ammo	No
Amber	C566C-AFN-CV0W0342	2130	4180	A3	587	A4	593	Ammo	No

### Notes:

1. The above kit numbers represent order codes that include multiple intensity-bin and color-bin codes. Only one intensity-bin code and one color-bin code will be shipped on each reel. Single intensity-bin, single color-bin codes will not be orderable.
2. Please refer to the "Cree LED Lamp Reliability Test Standards" document for reliability test conditions.
3. Please refer to the "Cree LED Lamp Soldering & Handling" document for information about how to use this LED product safely.

# Graphs

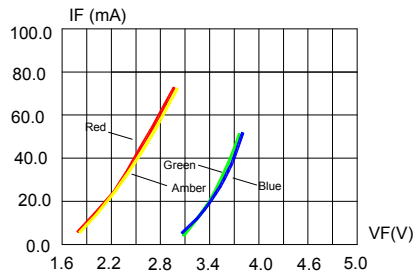

FIG.1 FORWARD CURRENT VS. FORWARD VOLTAGE.

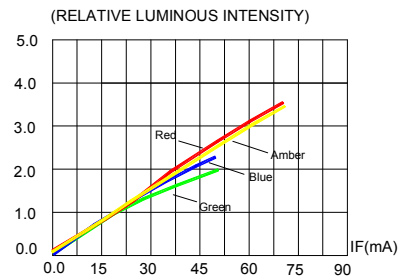

FIG.2 RELATIVE LUMINOUS INTENSITY VS. FORWARD CURRENT

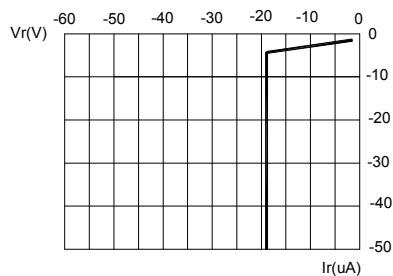

FIG.3a BLUE & GREEN REVERSE CURRENT VS. REVERSE VOLTAGE.

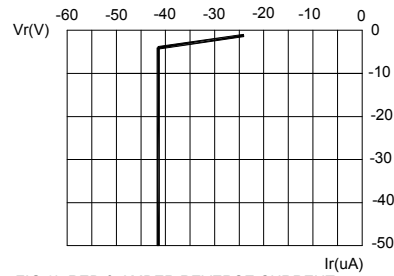

FIG.3b RED & AMBER REVERSE CURRENT VS. REVERSE VOLTAGE.

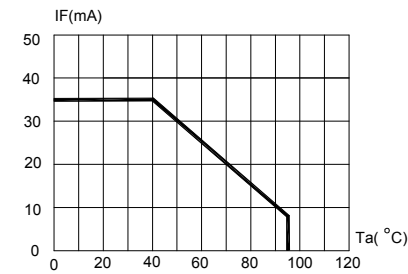

FIG.4a BLUE & GREEN MAXIMUM FORWARD DC CURRENT VS AMBIENT TEMPERATURE (Tjmax=105°C)

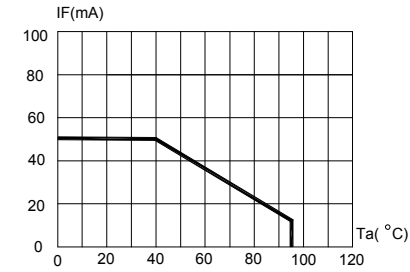

FIG.4b RED & AMBER MAXIMUM FORWARD DC CURRENT VS AMBIENT TEMPERATURE (Tjmax=105°C)

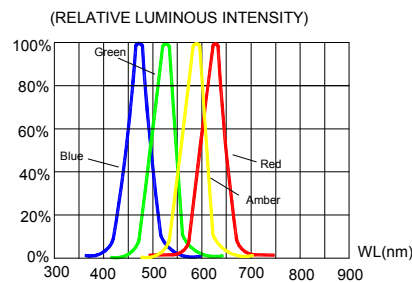

FIG.5 RELATIVE LUMINOUS INTENSITY VS. WAVELENGTH.

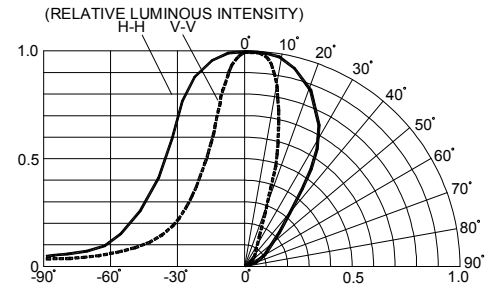

FIG.6 FAR FIELD PATTERN

The above data are collected from statistical figures that do not necessarily correspond to the actual parameters of each single LED. Hence, these data will be changed without further notice.

## Mechanical Dimensions

All dimensions are in mm. Tolerance is  $\pm 0.25$  mm unless otherwise noted.

An epoxy meniscus may extend about 1.5 mm down the leads.

Burr around bottom of epoxy may be 0.5 mm max.

C566C-RFS/GFS/BFS/AFS:

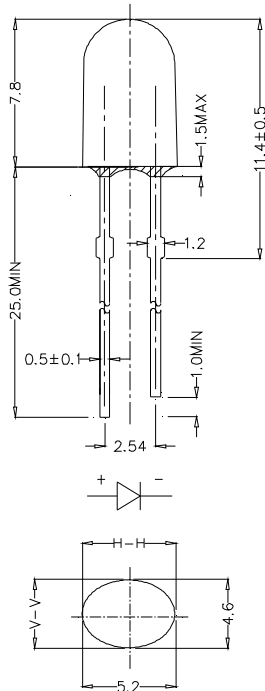

C566C-RFN/GFN/BFN/AFN:

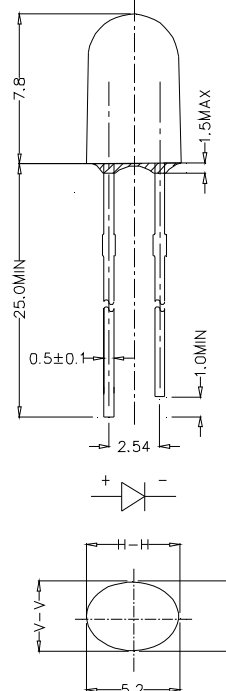

## Notes

### RoHS Compliance

The levels of environmentally sensitive, persistent biologically toxic (PBT), persistent organic pollutants (POP), or otherwise restricted materials in this product are below the maximum concentration values (also referred to as the threshold limits) permitted for such substances, or are used in an exempted application, in accordance with EU Directive 2002/95/EC on the restriction of the use of certain hazardous substances in electrical and electronic equipment (RoHS), as amended through April 21, 2006.

### Vision Advisory Claim

Users should be cautioned not to stare at the light of this LED product. The bright light can damage the eye.





## Kit Number System

Cree LED lamps are tested and sorted into performance bins. A bin is specified by ranges of color, forward voltage, and brightness. Sorted LEDs are packaged for shipping in various convenient options. Please refer to the "Cree LED Lamp Packaging Standard" document for more information about shipping and packaging options.

Cree LEDs are sold by order codes in combinations of bins called kits. Order codes are configured in the following manner:

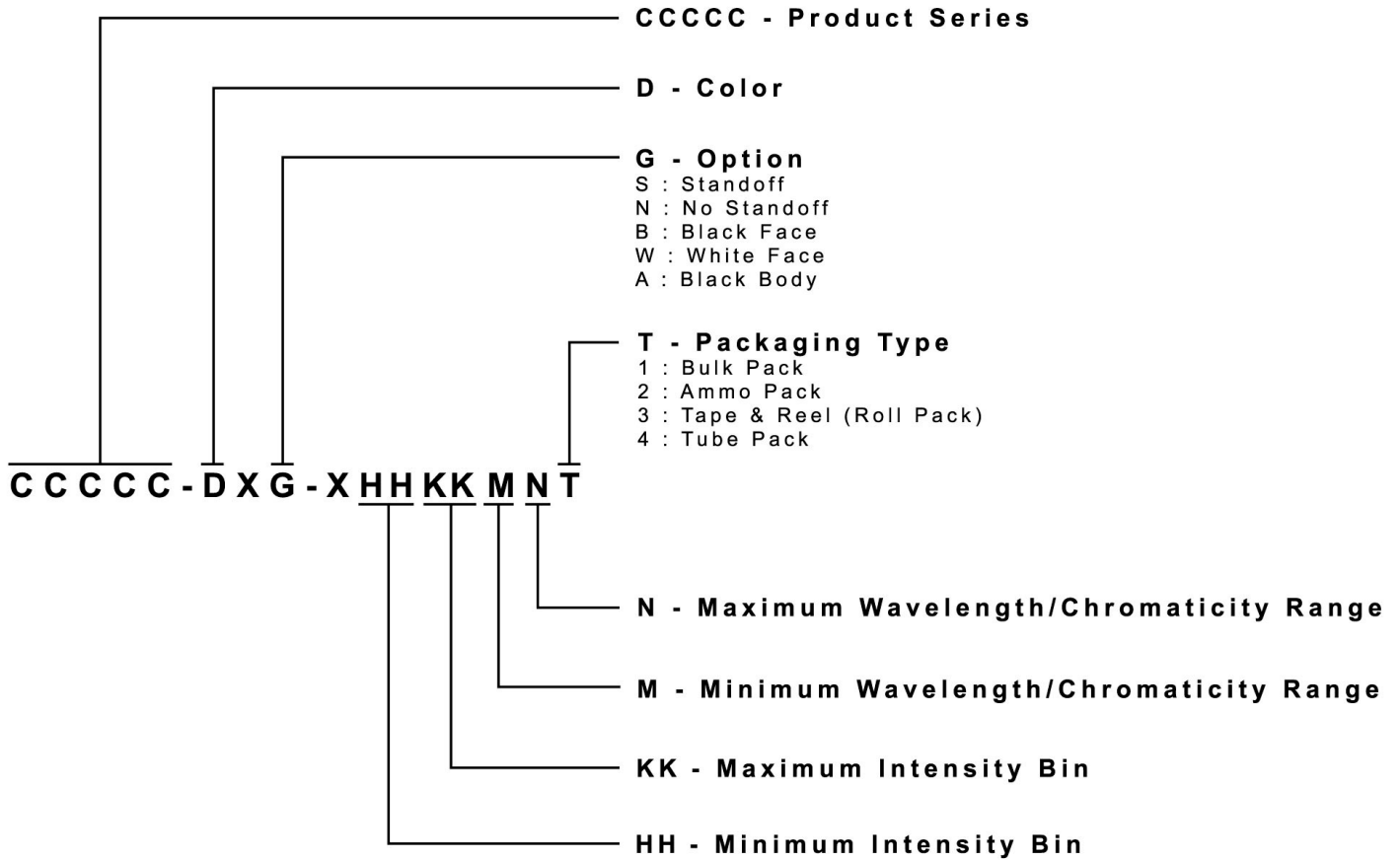

## Package

### Features:

- The LEDs are packed in cardboard boxes after packaging in normal or anti-electrostatic bags.
- Cardboard boxes will be used to protect the LEDs from mechanical shock during transportation.
- The boxes are not water-resistant, and they must be kept away from water and moisture.
- There are two types of packaging: bulk pack and ammo pack.
- Max 500 pcs per bulk and max 2500 pcs per ammo.

### Bulk Pack Packaging Type:

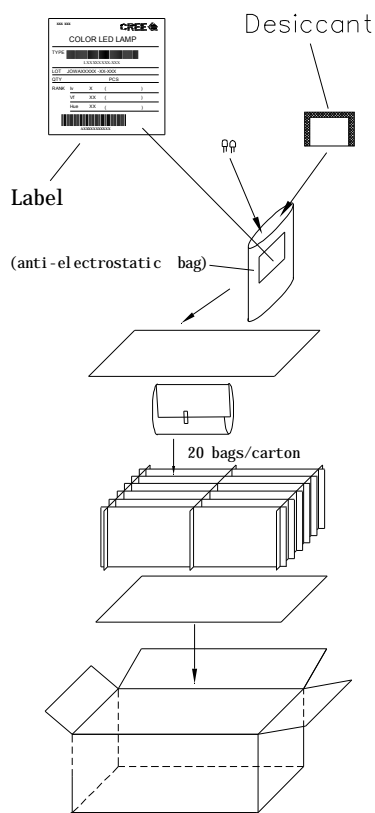

### Ammo Pack Packaging Type:

